

DUCATO

ŠASIJA

CJENIK VOZILA, OPREMA I TEHNIČKI PODACI

VELJAČA 2023

FIAT
PROFESSIONAL



CJENIK VOZILA I DODATNE OPREME

MODEL: 295 - Fiat Prof Ducato Heavy šasija dupla kabina

KODEKS	NAZIV MODELA	OBJAM [cm3]	SNAGA MOTORA [kW/KS]	UKUPNA SNAGA [kW/KS]	CO2 (g/km)	SJEDALA	INFO CIJENA DO REGISTRACIJE (EUR/KN)	CIJENA BEZ PPMV-a (EUR/KN)
295.AD3.9	Fiat Professional Ducato Heavy Šasija/Dupla kabina L2 17Q 2.2 140cv E6E MT (N1)	2.184	103 / 140	0 / 0	0		39.500	39.500
							297.613	297.613
295.AD4.9	Fiat Professional Ducato Heavy Šasija/Dupla kabina L2 17Q 2.2 140cv E6E AT (N1)	2.184	103 / 140	0 / 0	0		42.500	42.500
							320.216	320.216
295.BD3.9	Fiat Professional Ducato Heavy Šasija/Dupla kabina L3 17Q 2.2 140cv E6E MT (N1)	2.184	103 / 140	0 / 0	0		41.700	41.700
							314.189	314.189
295.BD5.9	Fiat Professional Ducato Heavy Šasija/Dupla kabina L3 17Q 2.2 180cv E6E MT (N1)	2.184	132 / 180	0 / 0	0		43.500	43.500
							327.751	327.751
295.BD6.9	Fiat Professional Ducato Heavy Šasija/Dupla kabina L3 17Q 2.2 180cv E6E AT (N1)	2.184	132 / 180	0 / 0	0		46.500	46.500
							350.354	350.354
295.CD3.9	Fiat Professional Ducato Heavy Šasija/Dupla kabina L4 17Q 2.2 140cv E6E MT (N1)	2.184	103 / 140	0 / 0	0		42.900	42.900
							323.230	323.230
295.CD5.9	Fiat Professional Ducato Heavy Šasija/Dupla kabina L4 17Q 2.2 180cv E6E MT (N1)	2.184	132 / 180	0 / 0	0		44.700	44.700
							336.792	336.792
295.CD6.9	Fiat Professional Ducato Heavy Šasija/Dupla kabina L4 17Q 2.2 180cv E6E AT (N1)	2.184	132 / 180	0 / 0	0		47.700	47.700
							359.396	359.396

Info cijena do registracije vozila uključuje PDV i PPMV (Posebni Porez na Motorna Vozila odnosno trošarinu) kod vozila koja su u obvezi plaćanja PPMV-a. Cijena dodatne opreme uključuje samo PDV, ali ne i PPMV. Iznos PPMV-a je informativan. Konačan iznos PPMV-a ovisi o odabranoj dodatnoj opremi i dimenzijama guma te se za detaljni izračun obratite svom partneru iz ovlaštene prodajne mreže. Za vozila raspoloživa na zalihima dostupan je konačan izračun PPMV-a (bazirano na podacima CO2 emisije s COC dokumenta konačne konfiguracije konkretnog vozila).

Cijene dvojno iskazane u HRK prema fiksnom tečaju za konverziju 7,53450.

AUTOCOMMERCE Hrvatska d.o.o. zadržava pravo izmjene cijena, opreme i tehničkih podatke bez prethodne najave. Za najnovije informacije obratite se ovlaštenom trgovcu.

Legenda: ■ = standardna oprema, - = nije moguće, P = dostupno isključivo kroz paket

Cijene su iskazane u eurima sa PDV-om i ne sadrže poseban porez na motorna vozila. Za detaljnu kalkulaciju molimo Vas kontaktirati ovlaštenog trgovca.

Cjenik vrijedi od: 20.02.2023

DIMENZIJE VOZILA I TOVARNOG PROSTORA *DUCATO*

L2 - ŠASIJA S DUPLOM KABINOM

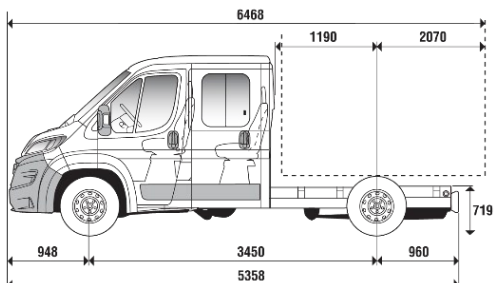

L3 - ŠASIJA S DUPLOM KABINOM

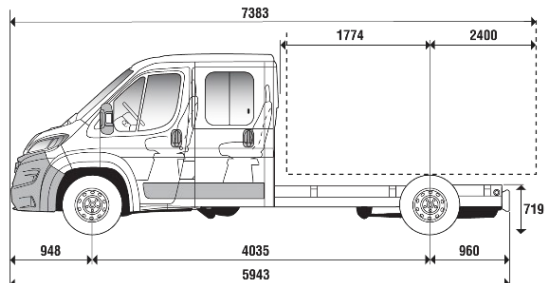

L4 - ŠASIJA S DUPLOM KABINOM

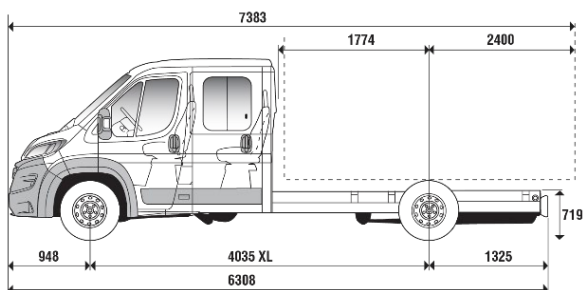

L3 - ŠASIJA S DUPLOM KABINOM + SANDUK

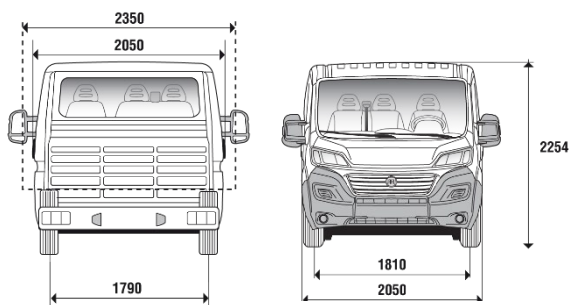
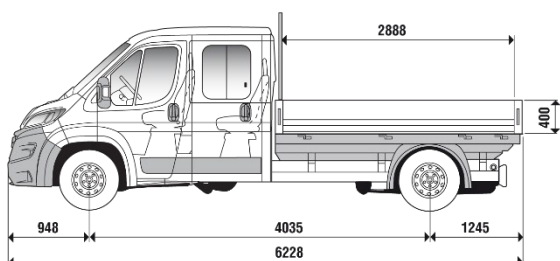



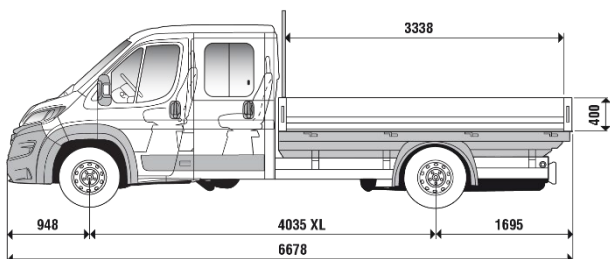





L4 - ŠASIJA S DUPLOM KABINOM + SANDUK



DIMENZIJE VOZILA I TOVARNOG PROSTORA

DUKATO

TABLICA

	L1	L2	ML	L3	L4
Međuosovinski razmak (mm)	3.000	3.450	3.800	4.035	4.035
Površina tovarnog prostora	5,7 m ²	6,6 m ²	7,3 m ²	7,8 m ²	8,5 m ²
Single cab					
Dužina (mm)	5.293	5.743	6.093	6.328	6.693
Površina tovarnog prostora	-	4,9 m ²	-	5,9 m ²	6,8 m ²
Double cab					
Dužina (mm)		5.738		6.228	6.678

ŠASIJA S KABINOM

Međuosovinski razmak (mm)	3000	3450	3800	4035	4035			
Kabina	single	single	double	single	single	double	single	double

Vanjske mjere (mm)

Dužina	5.293	5.743	5.738	6.093	6.328	6.228	6.693	6.678
Visina	2.254	2.254	2.254	2.254	2.254	2.254	2.254	2.254
Prevljes prednji	948	948	948	948	948	948	948	948
Prevljes zadnji	1.345	1.345	1.340	1.345	1.345	1.245	1.710	1.695
Širina (sa ogledalima)	2.690	2.690	2.690	2.690	2.690	2.690	2.690	2.690
Dužina sanduka	2.860	3.310	2.460	3.660	3.895	2.950	4.260	3.400
Širina sanduka	2.100	2.100	2.100	2.100	2.100	2.100	2.100	2.100

Dimenzije tovarnog prostora (mm) - sanduk

Dužina	2.798	3.310	2.460	3.598	3.895	2.950	4.260	3.400
Visina	2.034	2.034	2.034	2.034	2.034	2.034	2.034	2.034
Površina tovarnog prostora (m ²)	5,7	6,6	4,9	7,3	7,8	5,9	8,5	6,8

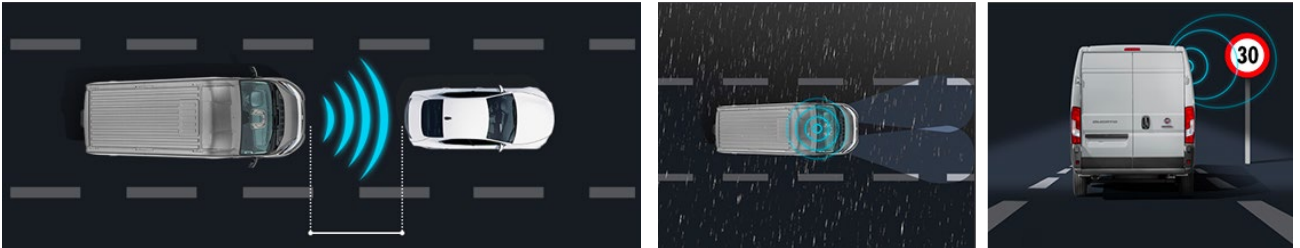



CJENIK VOZILA

Info cijena do registracije vozila uključuje PDV i PPMV (Posebni Porez na Motorna Vozila odnosno trošarinu) kod vozila koja su u obvezi plaćanja PPMV-a. Cijena dodatne opreme uključuje samo PDV, ali ne i PPMV. Iznos PPMV-a je informativan. Konačan iznos PPMV-a ovisi o odabranoj dodatnoj opremi i dimenzijama guma te se za detaljni izračun obratite svom partneru iz ovlaštene prodajne mreže. Za vozila raspoloživa na zalihii dostupan je konačan izračun PPMV-a (bazirano na podacima CO2 emisije s COC dokumenta konačne konfiguracije konkretnog vozila).
 AUTOCOMMERCE Hrvatska d.o.o. zadržava pravo izmjene cijena, opreme i tehničke podatke bez prethodne najave. Za najnovije informacije obratite se ovlaštenom trgovcu. Cijene su iskazane u kunama sa PDV-om i ne sadrže poseban porez na motorna vozila. Za detaljnu kalkulaciju molimo Vas kontaktirati ovlaštenog trgovca.



AUTOCOMMERCE HRVATSKA d.o.o., član grupe Emil Frey
 Kovinska 22, HR-1000 Zagreb
 T: +385 1 38 69 001 • info@autocommerce.hr

